

NEOLED™ MINI

ARCHITECTURAL FLEXIBLE LINEAR LED NEON

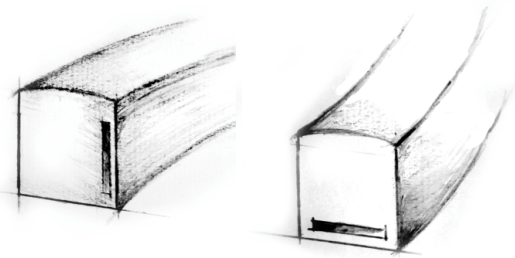

10 X 10MM

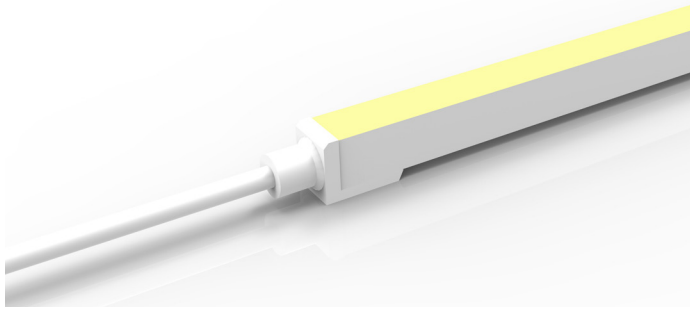
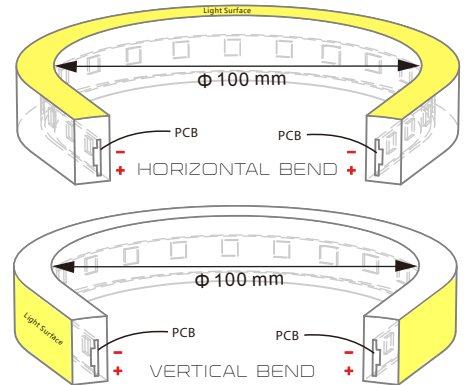

IP20-65 PROTECTION



120 BEAM ANGLE



IK08 PROTECTION



100MM BEND



SOLVENT RESISTANT



FLAME RESISTANT



UV RESISTANT



SALTWATER RESISTANT



WARRANTY

Technical Parameters

Colour	White/Red/Green/Blue/Amber
Voltage	DC24V
Power Per Metre	4.5 Watts
LED Quantity Per Metre	144
LED Pitch	6.9mm
LED Type	SMD
LED Beam Angle	120°
Minimum Bend Diameter	100mm
Minimum Cutting Led Quantity	12 Led's (1 unit)
Minimum Cutting Length	83.3mm (1 unit)
Continuous Length SGL/DBL Feed	10/20 Metres
Weight Per Metre	140g
Storage Temperature	-20 - 60°C
Working Temperature	-20 - 45°C
Dimensions - (W x H)	10mm x 10mm
Bend - Vertical (VB) Horizontal (HB)	VB/HB

Injection Moulded Connectors - IP40

Tolerance of Connectors is +/- 0.5mm



Rear Connector

Rear Cable Feed
Available in
0.3m, 1m & 3m lengths

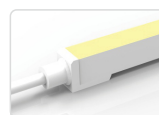
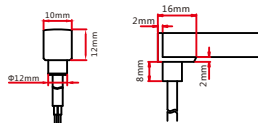

End Connector

End Cable Feed
Available in
0.3m, 1m & 3m lengths

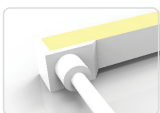
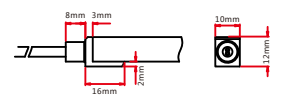

Side Connector

Side Cable Feed (L or R)
Available in
0.3m, 1m & 3m lengths

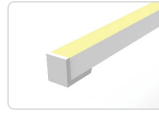
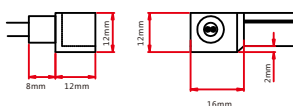

End Cap

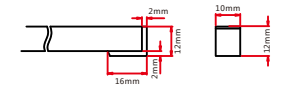

IP20 Connectors available on request

NEOLED™ MINI

ARCHITECTURAL FLEXIBLE LINEAR LED NEON

Photometric Data

Colour	CCT	Lumens per Metre
White - 2700K	2725 +/- 145K	>140lm
White - 3000K	3045 +/- 175K	>140lm
White - 4000K	3985 +/- 275K	>140lm
White - 5700K	5669 +/- 355K	>140lm
Wavelength		
Red	618-624nm	>50lm
Green	522-528nm	>200lm
Blue	468-474nm	>30lm
Amber	588-594nm	>50lm

Aluminium Linear/Flexible Mounting Channel

Lengths Available - 35 & 1,000mm

Standard

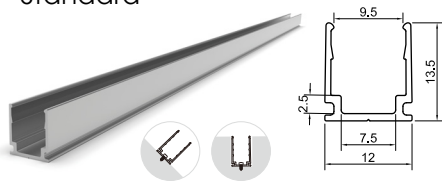

Hybrid

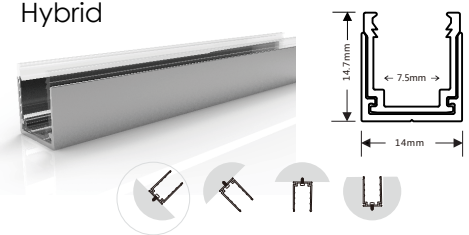

Recessed

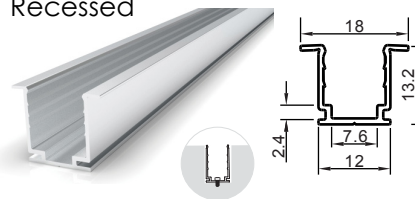

Injection Moulded Connectors - IP65

Tolerance of Connectors is +/- 0.5mm



Rear Connector
Rear Cable Feed
Available in 0.3m, 1m & 3m lengths

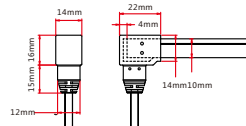

End Connector
End Cable Feed
Available in 0.3m, 1m & 3m lengths

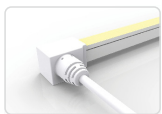
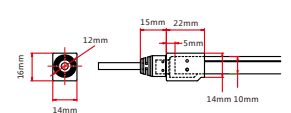

Side Connector
Side Cable Feed (L or R)
Available in 0.3m, 1m & 3m lengths

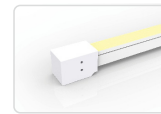
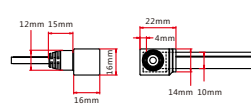

End Cap

